

# Data Sheet



Article number: 12859100050880

Description: KLEE-coil 859 100 050.880  
M5 Brass

## Measures

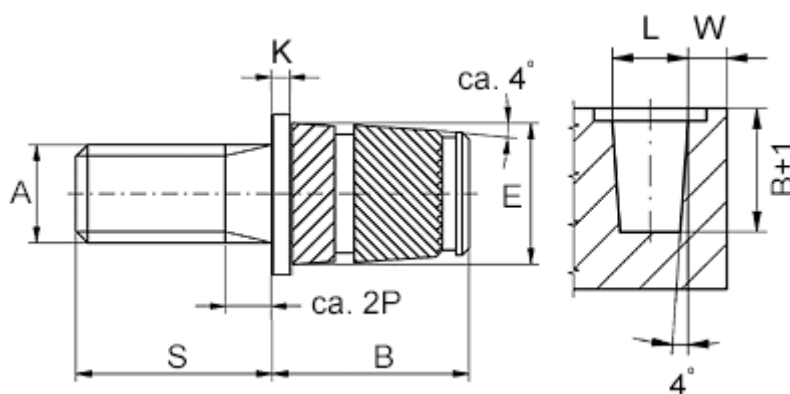

Flange diameter E1	= 9.0
Flange height	= 1.0
Male thread A	= M5x0,8
Min distance to edge W	= 2.0
Mounting length B	= 10.0
Outer diameter E	= 7.2
Pin length S	= 25
Recommended bore diameter W +0.1	= 6.9